

FlexSub – Features, Benefits, & Application Notes:

Triad FlexSubs provide installers with unprecedented flexibility in subwoofer installation, applications, and appearance. With performance similar to their InRoom, InWall & InCeiling counterparts, FlexSubs are available in two sizes & performance classes: Mini with 8 inch 4 or 8 ohm driver & RackAmp 300 or 700 (with 8 ohm only) and Silver with 12 inch 4 ohm driver & RackAmp 700. They use a damped, coiled, flexible tube 19" (Mini) or 24" (Silver) to 40" in length, to remotely feed two different types of grill assemblies. Included is either a traditional small Triad grill or an HVAC style Vent Outlet. These grills can be custom paint matched by Triad.

High performance FlexSubs can be installed in attics, crawl spaces, floors, ceilings, walls, closets, stairwells, baseboards, cabinet toekicks, and other spaces where limitations prevent the installation of conventional subs. FlexSub performance can be tweaked using our RackAmp 700 DSP's 6-band RoomEQ via IP.

FlexSub Parts Notes:

FlexSubs have 2 grill options: Small Triad sized grills (W for Mini; S for Silver) & HVAC style Vent Outlets. Grills must be specified when ordered. See grill install instructions overleaf on page 2.

The standard FlexSub tube length is 40". Tubes can be cut to a minimum of 19" (Mini) & 24" (Silver) with a utility knife and heavy duty wire cutter. The two plywood struts are for ceiling or floor joist mounting.

Hint: First install the part, enclosure or vent/grill outlet, with the most limiting install location. Then route the tube to the other location and install it into its assembly.

FlexSub Parts:

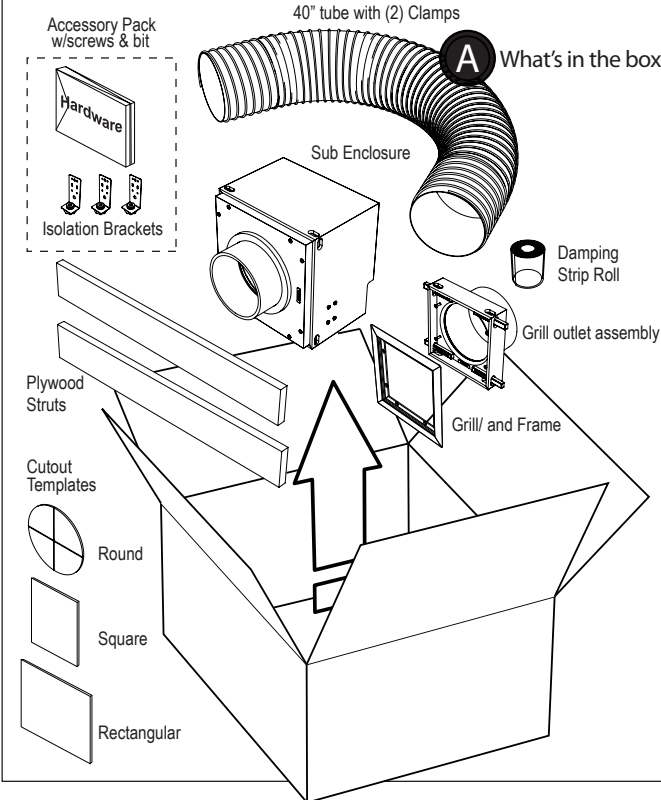

Common to most installs: Install & connect the enclosure (Mini FlexSub shown)

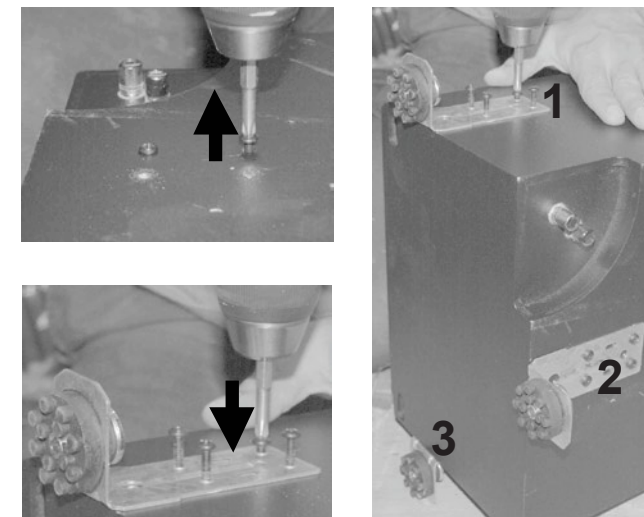

- B** After removing the 3 groups of 4 bracket screws from the back & 2 sides of the Sub Enclosure, screw the three (3) isolation brackets onto the enclosure.
- ⚠** Do not press screws down so hard that their inserts are forced into the enclosure. To avoid air leak noise, these 12 screws **MUST** be reinstalled hand tight.

- **Round MDF template**, included with every FlexSub, is used to cut holes for routing the tube. See Toekick Install on Page 2.
 - **Rectangular MDF template** is for cutting in HVAC style Vent grills.
 - **Square cardboard template** is for cutting in Triad style grills.
- ⚠ Warning:** To avoid rattles and vibrations, the tube should be routed free and clear of contact with adjoining surfaces. If necessary, dampen points where tube contacts adjoining surfaces. Confirm with subwoofer rattle test.

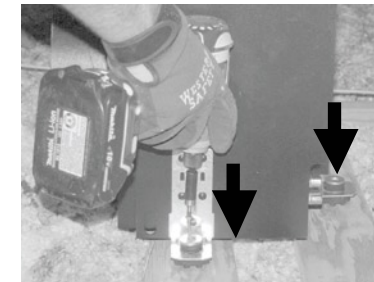

- C** Screw the 3 brackets into the two Plywood Struts using the supplied 2" self drilling torx head screws.

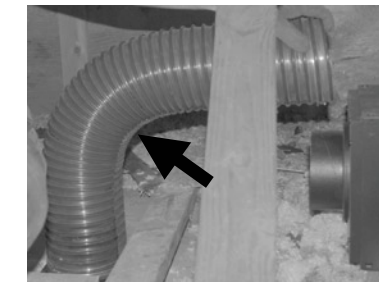

- D** Temporarily position the tube between the enclosure and Vent Outlet. On the inside of the bend radius, where the coils touch, you will dampen them in Step E.

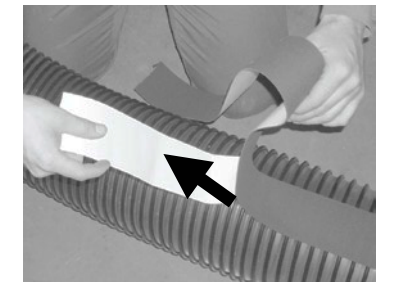

- E** Straighten hose. Apply damping strip along the *inside* of the tube's bend radius. As you remove the adhesive backing, press the strip taut across the coils where they touch. Trim & save extra foam.

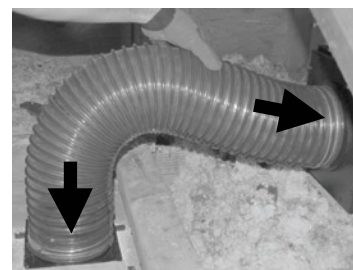

- F** Seat the tube around the adaptor at each end, keeping the damping strip along the tube's inside radius.
- Position the enclosure and 2 struts.

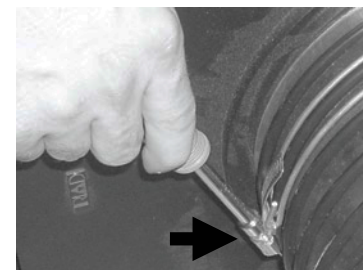

- G** Using a std nut driver, firmly tighten both clamps, sealing the tube around the adaptors.
- ⚠** Don't strip clamps by over-tightening, particularly with a power tool.

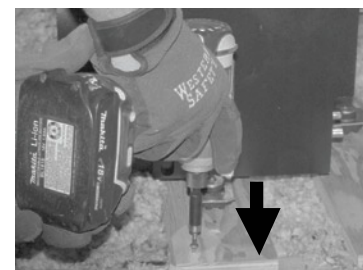

- H** Screw the struts into the joists using the supplied 2" torx head screws.
- Tie down the tube to keep it from rattling against any nearby surface. Add damping strip to any touch points.

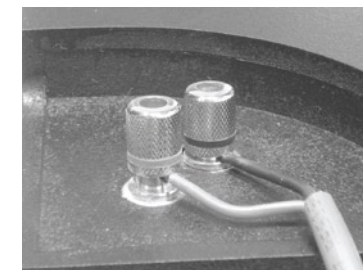

- I** Connect speaker wires from RackAmp to the enclosure's binding posts keeping correct polarity. Retighten just before completing installation.
- See overleaf for RackAmp settings.

SET UP RACKAMP (SEE OVERLEAF); TEST SYSTEM AT MODERATE VOLUME LEVELS



- K** Finished Installation.

Install Vent Assembly (Silver Vent Assembly shown):

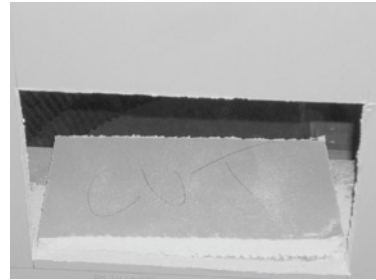

A Using the supplied MDF wood template, level, trace & cut a hole the size of the Vent Outlet body into the face of the mounting surface.

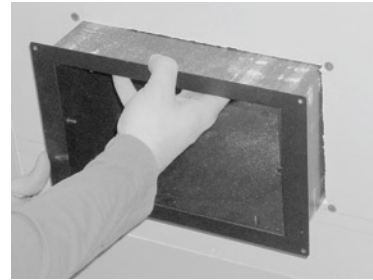

B Press-fit the Vent Outlet through the front of the opening; mark the four screw hole locations.

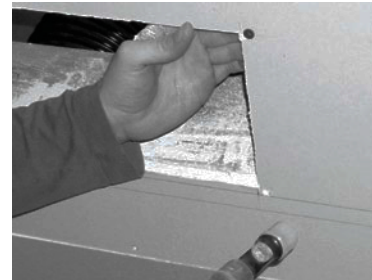

B2 For drywall installs, remove the Vent Outlet and drill 4 holes sized for your fastener/anchors.

Install four fastener/ anchors into the face of the drywall.



C Insert the Vent Outlet & grill into the face of the hole; screw them firmly to the mounting surface using the 4 supplied screws.

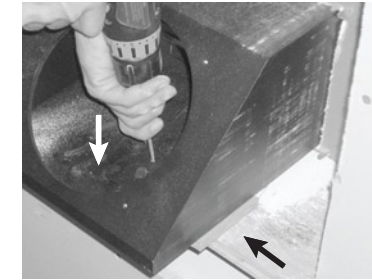

D At the back, shim the vent outlet bottom to the correct height and screw the outlet body tightly & securely through the shim into the surface below.



E Attach the mounting flange to the back of the Outlet body using the supplied screws (4 for Silver / 5 for Mini).

Hint: For flush install in material other than drywall, route its surface the depth of the Vent grill face plus its Outlet Flange.

Install W or S sized Grill Assembly (W Grill Assembly for Mini shown):

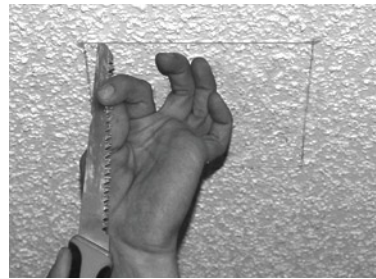

A Using the supplied template, trace and cut a hole into face of the mounting surface.

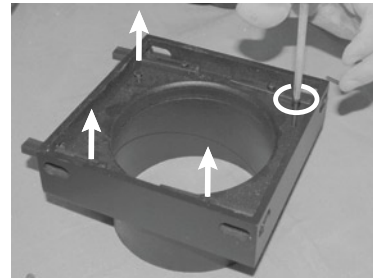

B From the face of the Grill Outlet remove the 4 screws not holding the retro brackets.

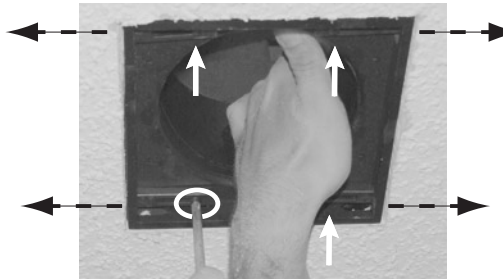

C Insert Grill Assembly into the hole from the front. Fully extend and tighten the retro brackets behind the mounting surface.

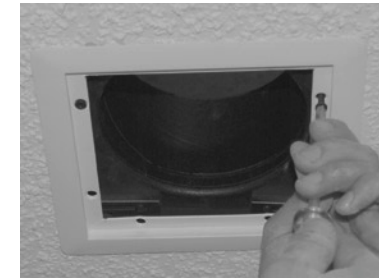

D Using the four screws previously removed, screw the frame into the Outlet face, snugly sandwiching the mounting surface between the Grill frame and Outlet.

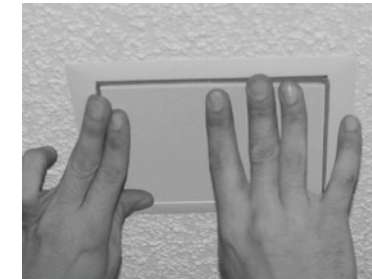

E Press fit the grill into the frame.



F Mini FlexSub with W Grill.

RackAmp 700 DSP has Pick Sub selections for 1 Silver and 1 or 2 eight ohm Mini FlexSubs. RA 300 has selection for 1 four ohm Mini FlexSub.

Note: Select the appropriate "Pick Sub" model and Preset for each FlexSub model as shown below. You can further optimise RackAmp DSP for Flexsubs using Room EQ's 6 Band PEQ set up via a computer.

Custom Grills – If you are using onsite custom made grills or cabinet openings for FlexSubs, it is important to provide enough clear opening to avoid chuffing and to let the subs perform optimally. Here are the minimum clear openings that will let FlexSubs vent properly into a room:

Mini: At least 16 square inches of opening.

Silver: At least 42 square inches of opening. (You can achieve this with three (3) Mini Vent Grills.)