

SONANCE

BEYOND SOUND

MULTI-CHANNEL POWER AMPLIFIER
16-50 | 8-50
INSTALLATION AND SUPPORT MANUAL

MULTI-CHANNEL POWER AMPLIFIER

SONANCE 16-50 | 8-50 AMPLIFIER

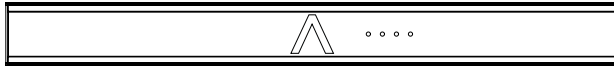

8-50 FRONT

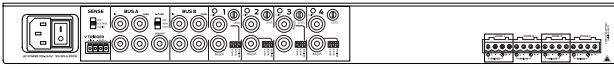

8-50 BACK



16-50 FRONT

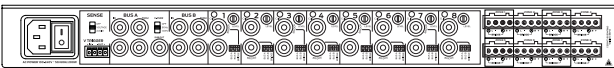

16-50 BACK

TABLE OF CONTENTS

2	Box Contents
2	Introduction
2	Important Safety Information
3	Product Description
3	Placement
3	Quickstart Guide
4	Unpacking and Record Keeping
4	Stacking Multiple Amplifiers
4	Operating the Amplifier
5	Recommended Tools, Cables, and Wires
5	Instruction Manual
5	Front and Rear Panel Features
6	AC Power Socket and Trigger Mode
6	Line Inputs/Loop Outputs
8	Amplifier's Power Requirements
8	Speaker Connections
8	Bridging Channels
9	Protecting Circuitry, LEDs, and Speakers
9	Amplifier Stacking
10	Shelf and Rack Mounting
10	Installation
11	Troubleshooting
15	Uninstalling for Relocation or Service
16	Specifications
16	Replacement Accessory Parts
17	Warranty Statement

BOX CONTENTS

- (1) Quickstart Guide
- (1) Sonance Amplifier (8-50 or 16-50 Model)
- (1) AC Power Cord (North America Units Only)
- (4) Amp Feet
- (2) Rack Ears
- (4 or 8) Speaker Block Connectors
- (1) Voltage Trigger Block Connector

INTRODUCTION

Thank you for selecting the Sonance 16-50 or 8-50 multi-channel amplifier. Sonance has over three decades of experience in premium distributed audio amplification. The amplifier has been precision engineered to provide maximum installation flexibility, low energy consumption and audiophile sound in a compact form factor (1RU). Please take the time to carefully read through the manual, study the illustrations and system diagrams. This extra time can lead to trouble free operation and continued musical enjoyment.

IMPORTANT SAFETY INSTRUCTIONS

You should always follow these basic safety precautions when using your Sonance Amplifier to reduce the risk of fire, electric shock, and injury to persons.

READ THIS DOCUMENT IN ITS ENTIRETY BEFORE ATTEMPTING USE.

1. Read and retain instructions: Read all the safety and operating instructions before operating the amplifier and retain them for future reference.
2. Heed warnings: Adhere to all warnings and precautions listed on the amplifier and in the operating instructions.
3. Follow all operating instructions.
4. Never use the amplifier next to water.
5. Carts and Stands: Use only with a cart or stand that is recommended by the manufacturer. Move with care.
6. **CAUTION: TO PREVENT ELECTRIC SHOCK, DO NOT USE THE POLARIZED PLUG WITH AN EXTENSION CORD, RECEPTACLE, OR OTHER OUTLETS UNLESS THE BLADES CAN BE FULLY INSERTED TO PREVENT BLADE EXPOSURE.**
7. Ventilation: Situate the amplifier so that its location does not interfere with its proper ventilation.
8. Heat: Situate the amplifier away from heat sources such as radiators, stoves, etc. (including amplifiers).
9. Grounding or Polarization: Precautions that should be taken so that these attributes are not defeated.
10. Power-Cord Protection: Route power supply cords so they will not be walked on or pinched by items.
11. Cleaning: Use "canned air" or wipe the amplifier with a

soft cloth. Do not use solvents, as they may damage the amplifier.

12. Non-Use Periods: Unplug the amplifier's power cord from the outlet when the amplifier will be left unused for a long period of time.
13. Object Entry: Care should be taken so that objects do not fall through the opening of the enclosure.
14. Moisture: Do not expose the amplifier to dripping or splashing. Do not place objects filled with liquids, such as vases, on the amplifier.
15. Damage Requiring Service: Have the amplifier serviced by a qualified service technician when the power cord or power supply is damaged, the amplifier has been dropped or the enclosure is damaged, something has spilled into the amplifier, it has been exposed to rain, or the amplifier is not operating properly.
16. Servicing: Do not attempt to self service the amplifier. Contact Sonance Tech Support for servicing options.
17. Power Requirement: Do not connect the Sonance amplifier to the accessory outlet of any other component. Connection to a grounded mains power outlet is required.

WARNING: THE POWER (MAINS) PLUG SERVES AS THE AMPLIFIER'S DISCONNECT DEVICE. THE DISCONNECT DEVICE SHALL REMAIN READILY OPERABLE DURING OPERATION. TO ENSURE THAT THE DISCONNECT DEVICE IS EASILY ACCESSIBLE, THE USER SHALL NOT PLACE THE AMPLIFIER IN A CONFINED AREA DURING OPERATION.

18. Storms: To prevent damage to components, unplug all electronic equipment during thunderstorms.
19. Unplug by grasping the plug, do not pull on the cord.

WARNING: ANY CHANGES OR MODIFICATIONS TO THIS UNIT NOT EXPRESSLY APPROVED BY THE PARTY RESPONSIBLE FOR COMPLIANCE COULD VOID THE USER'S AUTHORITY TO OPERATE THE EQUIPMENT.

NOTE: THIS EQUIPMENT HAS BEEN TESTED AND FOUND TO COMPLY WITH THE LIMITS FOR A CLASS B DIGITAL DEVICE, PURSUANT TO PART 15 OF THE FCC RULES. THESE LIMITS ARE DESIGNED TO PROVIDE REASONABLE PROTECTION AGAINST HARMFUL INTERFERENCE IN A RESIDENTIAL INSTALLATION. THIS EQUIPMENT GENERATES, USES AND CAN RADIATE RADIO FREQUENCY ENERGY AND, IF NOT INSTALLED AND USED IN ACCORDANCE WITH THE INSTRUCTIONS, MAY CAUSE HARMFUL INTERFERENCE TO RADIO COMMUNICATIONS. HOWEVER, THERE IS NO GUARANTEE THAT INTERFERENCE WILL NOT OCCUR IN A PARTICULAR INSTALLATION. IF THIS EQUIPMENT DOES CAUSE HARMFUL INTERFERENCE TO RADIO OR TELEVISION RECEPTION, WHICH CAN BE DETERMINED BY TURNING THE EQUIPMENT OFF AND ON, THE USER IS ENCOURAGED TO TRY TO CORRECT THE INTERFERENCE BY ONE OR MORE OF THE FOLLOWING MEASURES:

- Reorient or relocate the receiving antenna.
- Increase the separation between the equipment and receiver.
- Connect the equipment into an outlet on a circuit different from that to which the receiver is connected.
- Consult the dealer or an experienced technician for help.

PRODUCT DESCRIPTION

The Sonance 16-50 (16-channel power) and 8-50 (8-channel power) amplifiers are rated at 50W per channel into 8 Ohm loads, 100W per channel into 4 Ohm loads and 200W per bridged pair of channels into 8 Ohm loads. The internal stereo amplifier modules are audiophile grade, high-efficiency Class D. The amplifier is easily configurable for stereo and/or bridged operation and can pass paging and doorbell chimes when these signals are connected to the Bus Inputs. The amplifier is compatible with 4 Ohm speakers in stereo mode and 8 Ohm speakers in bridge mode. Bridged operation is useful for higher power output applications such as driving a passive subwoofer or an outdoor 8 Ohm satellite and subwoofer system. Audio source connections can be made into the 'Local' RCA inputs for individual use or into one of the Bus Inputs for distribution using the Zone Configuration Input Assignment DIP switches. Busing allows for a single source to be connected to one or more of the amplifier zones without the need for additional cabling. It is possible to turn multiple Zone Configuration Input Assignment DIP switches to ON to allow for multiple inputs to play together such as with use of paging or door bell chimes. The paging and door chimes will then be heard along with the audio source(s). The 16-50 and 8-50 has a comprehensive protection circuit that guards against shorted outputs, over-current, over-temperature, low AC voltage (brownouts) and excessive AC voltage.

PLACEMENT

The 16-50 and 8-50 features fan assisted cooling utilizing vents on both sides of the chassis. Ensure the sides of the amplifier have a least 3" (75mm) of clearance to the sides of the rack or equipment cabinet to allow for proper air flow.

The amplifier should be placed in a dry, non-condensing environment with ventilation. Locate the amplifier so it is completely isolated from temperature extremes, rain, snow, direct sunlight and atmospheric contaminants. Do not locate the amplifier outdoors. Any moisture related damage such as from condensation is not covered by the factory warranty. Although the amplifier includes fan-assisted cooling, some heat is still produced. Locate the amplifier on a shelf or at the lowest place in a rack that has good circulation of fresh air to dissipate heat. Do not place the amplifier in a closed cabinet or closet with little ventilation as this can reduce its service life.

QUICKSTART GUIDE

The Quickstart Guide is intended for the installer who is familiar with the 16-50 or 8-50 and has reviewed the chapters on 'Important Safety Instructions' and 'Placement'.

Application One

One Analog audio source, such as a music streamer, into the Bus A inputs for internal distribution to all eight (16-50) or four (8-50) stereo Zone outputs.

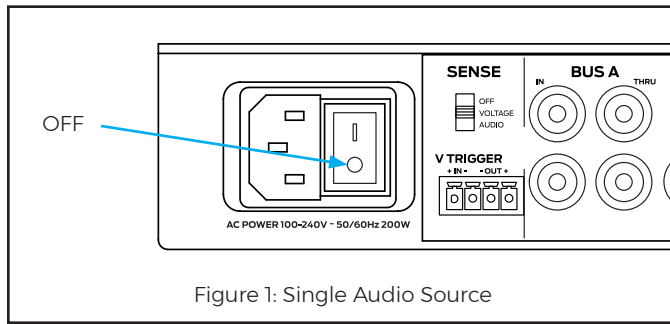

Figure 1: Single Audio Source

1. Ensure the 16-50 or 8-50 is in the OFF state. The rear panel Power Switch should be in the down position.
2. Decide on the appropriate Power Sensing Mode: Voltage, Audio Signals or the “always on” OFF position such as for passing paging or doorbell chimes.
3. Set the Sense DIP switch accordingly.
4. If using the voltage trigger feature, connect a two-conductor wire from the 12 volt output of a zone preamp or DC power supply into the ‘V Trigger’ inputs on the amplifier.
5. Connect a pair of RCA cables from the single source into the left and right Bus A inputs on the amplifier.
6. Set the channel Input Assignment DIP switches to Bus A.
7. Connect speaker wire from the speakers to their dedicated Speaker Output Block Connector.
8. If the AC cord is disconnected, then reconnect it.
9. Push the power switch up to the ON position.
10. With the volume on the source turned down to a low, speaker friendly level, activate the amplifier to play music. If you do not hear any sound, refer to the ‘No Audio’ section of the Troubleshooting chapter of this manual.
11. Adjust volume output with Zone Level controls.
12. Follow the steps in the chapter entitled, ‘Protecting Speakers from Damage’.

Application Two

Four analog audio sources, such as four music streamers or four line-level outputs of a multi-zone preamp into the local (direct) inputs.

1. Ensure the amplifier is in the OFF state. The rear panel power switch should be in the down position.
2. Decide on the appropriate Power Sensing Mode: Voltage, Audio Signals or the ‘always on’ OFF position (such as for the passing paging or doorbell chimes).

3. Set the Sense DIP switch accordingly.
4. If using the voltage trigger feature, connect a two-conductor wire from the 12 volt output of a zone preamp or DC power supply into the ‘V Trigger’ inputs on the amplifier.
5. Connect a pair of RCA cables from each stereo source into their dedicated local source inputs.
6. Connect 14/4 speaker wire from the remote zones to their dedicated Speaker Output Block Connector.
7. If the AC cord is disconnected, then reconnect it.
8. Push the power rocker switch up to the ON position.
9. With the source volume turned down to a low, speaker friendly level, turn the amplifier on and play music. If you do not hear any sound, refer to the ‘No Audio’ section of the Troubleshooting chapter.
10. Adjust volume output with Zone Level control.
11. Follow the steps in the chapter entitled, ‘Protecting Speakers from Damage.’

UNPACKING AND RECORD KEEPING

Save the box and its interior packing material in a dry, protected space. The box and packing are vitally important to protect the amplifier should it need to be transported for service or relocation in the future.

The information below is critically important for warranty claims, advanced troubleshooting, parts inquiries and insurance replacement. The amplifier’s serial number is located on a label on the back panel below a bar code. In addition, please keep a copy of your dealer’s sales invoice listing the amplifier with the serial number in a secure place. These are crucial time-saving steps for the future, if a warranty claim becomes necessary.

S/N: _____
DATE OF SALE: _____
DEALER NAME: _____
CONTACT INFO: _____

STACKING MULTIPLE AMPLIFIERS

Multiple amplifiers can be directly stacked with the feet removed for use in low to moderate output applications. For high output applications, provide at least 1U space (1.75”/44.4mm) between amplifiers for increased ventilation.

OPERATING THE AMPLIFIER

The 16-50 and 8-50 were designed to be ultra-simple to operate once installed. When the ‘Sense’ mode is set to ‘Voltage’ and a 3-30V DC voltage is applied, the unit will produce sound after approximately one second. When 3-30V DC is removed, the amplifier will enter a low power standby state after ten seconds. When the ‘Sense’ mode is set to ‘Audio’ and an audio input above 1.5mV is detected, the unit will produce sound after approximately

one second. When the audio signal is removed, the amplifier will wait 15 minutes and then enter a low power draw state. This ensures that if the music is paused or has a quiet period for a short time, the amp will produce sound immediately.

RECOMMENDED CABLE AND WIRE

- Stereo Line-Level RCA Interconnect Cable
- (1) Two or four conductor speaker wire relative to the application
- (2) Two-conductor speaker wire is also acceptable

RECOMMENDED INSTALLATION TOOLS

- Phillips #2 screwdriver
- Speaker wire strippers
- Small jewelers style flat blade screwdriver
- Self-adhesive wire labels

8-50 AND 16-50 INSTRUCTION MANUAL

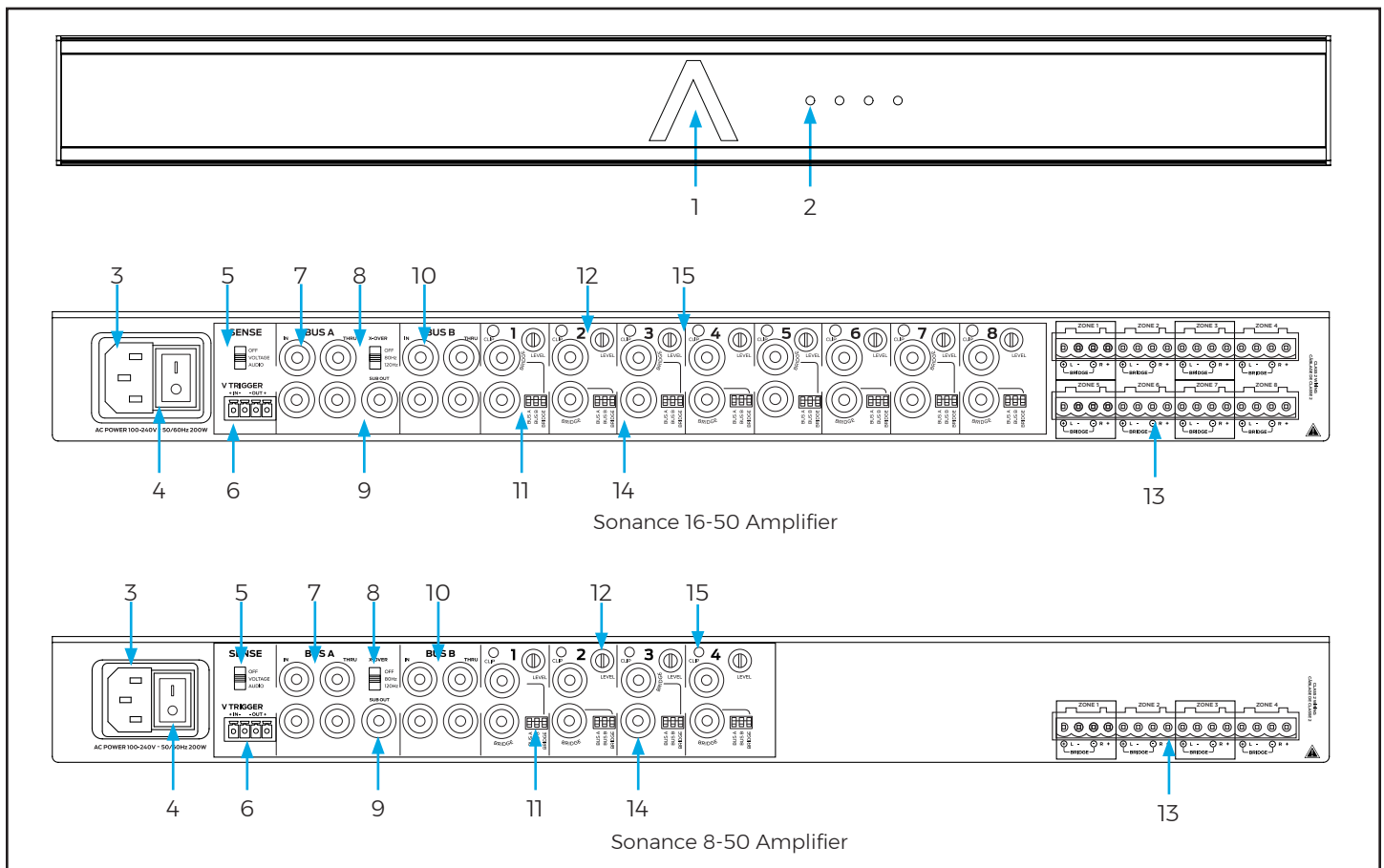

FRONT PANEL

1. System Status Indicator
2. Zone Status Indicator

REAR PANEL

3. AC Power Socket
4. AC Power Switch
5. Sense Switch
6. Voltage Trigger Connector
7. Bus A Input / Thru
8. Crossover Switch (Bus A)
9. Sub Out (Bus A)
10. Bus B Input / Thru
11. Zone Input DIP Switch
12. Zone Level Control
13. Zone Speaker Outputs
14. Zone Local Inputs
15. Zone Clip Indicator

FRONT PANEL

System Status Indicator (Beam Logo)

White: System is powered and in standby

Blue: System is powered and ready/active

Flashing Red: System fault, over temperature fault

OFF: System is off and not powered

NOTE: UPON INITIAL POWER UP, THE SYSTEM WILL UNDERGO A BOOT PROCESS THAT MAY LAST A FEW SECONDS. NO AUDIO WILL BE HEARD.

Zone Status Indicators

OFF: zone is not active (system is off or in standby)

WHITE: zone is active and ready. No signal is present or is too small to be detected

BLUE: zone is active and detects an input signal

FLASHING YELLOW: zone is active but is overdriven

RED: zone is in protection

AC POWER SOCKET

The 16-50 and 8-50 feature a removable IEC power connector for the AC socket. Plug the female end of the power cord into the AC Power Socket on the amplifier rear panel and plug the male end into a grounded wall socket. Do not plug the amplifier's power cord into a convenience outlet on any other audio or video component. If you need to use an extension cord, use only a heavy duty (14 gauge or larger) extension cord to avoid starving the amplifier of the current necessary for full operation.

TRIGGER MODE CONTROL

You can set the amplifiers so that they will automatically turn ON when it receives an audio signal, when it receives a control voltage from an external source, or to remain on and not enter standby.

NOTE: IF EITHER AUDIO OR VOLTAGE TRIGGERS ARE SELECTED, THE AMPLIFIER HAS A LESS THAN ONE SECOND CYCLE TIME FROM STANDBY TO PLAY AN AUDIO SIGNAL. THIS IS NORMAL AND REQUIRED TO COMPLY WITH THE EU <0.5 WATT ERP DIRECTIVE. SELECT OFF TO BYPASS THIS FEATURE. SEE POWER CONSUMPTION TABLE FOR IDLE POWER USE.

Auto On Triggering - Three Position Switch

AUDIO - In this mode, the amplifier will automatically turn ON when the minimum audio signal of 1mV is detected at any of the selected inputs (Local and/or Bus). This trigger takes less than one second to activate. The amplifier will turn off after 15 minutes of no input signal on all selected inputs.

VOLTAGE - When the Sense switch is set to voltage, the amplifier will automatically turn on when a voltage of 3-30V DC is detected. Connect the trigger voltage source to the input of the V Trigger using the left side of the green block connector. This trigger takes less than one second to activate.

OFF - When the Sense switch is in the top OFF position, the amplifier will remain ON and will not go into standby mode.

NOTE: WHEN THE AUTO ON SWITCH IS SET TO OFF THE AMPLIFIERS POWER SAVING FEATURE WILL BE DISABLED.

12V Trigger Output - The Sonance amp has a 12V Output two wire screw connector found on the right side of the green block connector that provides 12V DC whenever the amplifier is ON.

1. OFF/Power Switch: Useful if the amplifier needs to be always on without any delay between signal input and sound output.
2. Voltage Sensing: Optimum sensing option as it is impervious to false triggering and 100% predictable.
3. Audio Sensing: Simple option that controls the on/off state with the audio signal.

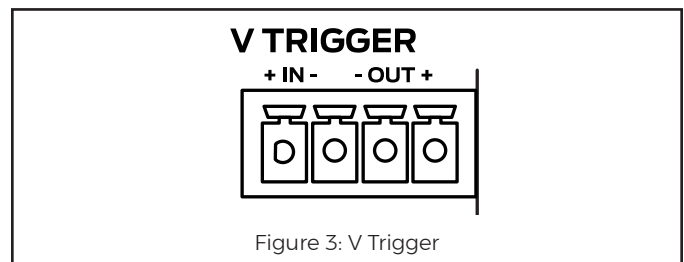
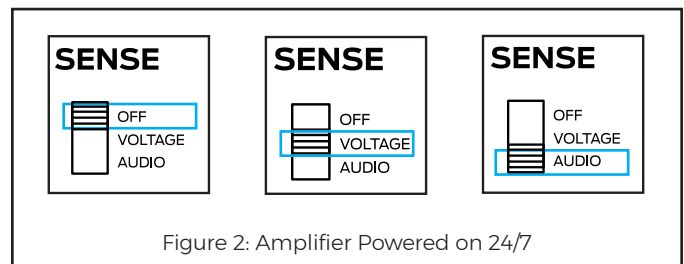

Connect a two-conductor wire from the 12 volt output of an AV receiver, zone amplifier, or control system to the voltage trigger IN. Voltage trigger OUT provides 12VDC anytime the amp is active. Do not exceed 100mA of current draw. Damage can occur.

LINE INPUTS/LOOP OUTPUTS

The amplifiers have BUS IN and THRU connections and zone-specific IN connections. The zone-specific IN connections are typically used with a multi-zone preamp to provide zone exclusivity.

BUS A and BUS B

To share one or two audio sources internally with more than one zone, the amplifier has BUS A and BUS B IN and THRU connections. The BUS inputs are useful for blending auxiliary sources together, such as for paging announcements and door chimes along with the audio source connected to the local inputs. Note: The paging and doorbell chimes cannot mute the local audio source - they will all be heard together.

There are three options when connecting audio inputs to the amplifier:

1. Zone Line In Connectors: Use the local inputs to dedicate one audio source to its corresponding zone speaker outputs.
2. Bus A Input: Use the Bus A input to pass an additional audio source, such as paging to any of the amplifier zones using the rear panel dip switches.
3. Bus B Input: Use Bus B input to pass an additional audio source, such as door chimes to any of the amplifier zones using the rear panel dip switches.

BUS THRU Outputs

Each of the Bus Inputs provide non-buffered loop outputs to allow multiple amplifiers to share common audio sources. The loop outputs on the amplifier are not buffered, and the number of amplifiers that can be connected in series will depend on the output capability of the audio source. The source connected to the LEFT and RIGHT IN connections passes through to the LEFT and RIGHT THRU Outputs. Always use high-quality, shielded interconnect cables.

BUS A SUB Out

BUS A has subwoofer output connection, which sums the signal from the LEFT and RIGHT IN connections. Setting the X-OVER switch to 80Hz or 120Hz will apply a low-pass filter to the SUB OUT signal. A matching high-pass filter will be applied to the BUS A signals routed to amplifier zones by the rear-panel dip switches. The BUS A THRU signals are unaffected.

The 80Hz setting is the proper setting for most subwoofer applications when used with large and medium main speakers. The 120Hz setting is typically used with smaller main speakers or when more bass is required in a larger room.

1. Connect a stereo line-level source with an RCA cable into the BUS A Left and Right IN.
2. Connect a single RCA cable from the SUB OUT jack to the line-level input on a powered subwoofer, such as a Sonance D8, i8, i10, or i12.

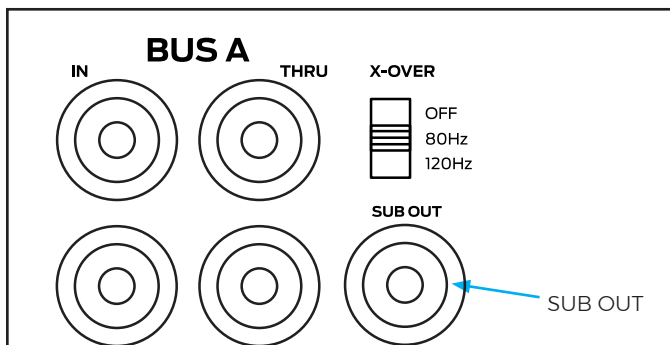

Figure 4: Using the Subwoofer Line-Level Output with the Bus A Inputs (not applicable with the Bus B or local inputs)

If using a separate power amplifier, connect the cable from the SUB OUT jack to the input specified in the manual for that power amplifier. If a zone in this amplifier is being used in bridged mode (8 ohms minimum), use the Zone IN connection labelled "BRIDGE" as described in the "BRIDGING CHANNELS" section of the manual.

Input DIP Switch Assignments

The DIP switches enable one or more audio sources to be played through one or more speaker outputs simultaneously. The amplifier channels can then be set to the local (direct) source, Bus A signal input and/or Bus B signal input. Turning the DIP switch to 'ON' causes the source to play through the assigned speaker output.

Two zone example, the home could be subdivided into two zones with two audio sources. One source connected into Bus A and a second source into Bus B (not into the Local Input). Set one half of the amplifier's DIP switches to Bus A and the second half of the amplifier set to Bus B. Control system example, the input connections can all be local for a discrete four zone system with Bus A switched 'ON' for doorbell monitoring and Bus B ON for paging duties. What will be heard in each zone depends on the sources connected to the various inoputs and the DIP switch settings.

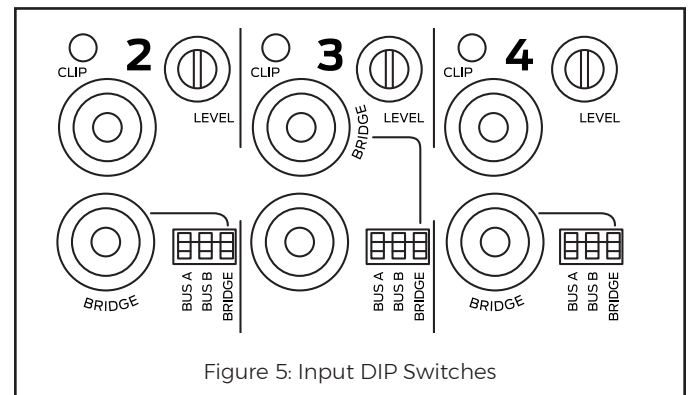
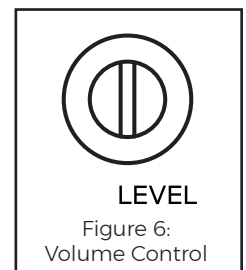

Figure 5: Input DIP Switches

Zone Trim Controls

Each zone on the amplifier has a volume adjustment accessible on the rear panel of the amplifier. This control is a TRIM control, not a volume knob, so the minimum gain setting (fully counter-clockwise) will not turn off the output. The range of adjustment is +15 to +30dB of gain. The zone trim control is intended to be set below the point at which amplifier and speakers distort, thereby preventing speaker damage. The volume controls also allow balancing of the sound levels of different zones or the outputs of the right and left channels to compensate for various room characteristics or seating arrangements.



IMPORTANT: DO NOT COMBINE NEGATIVE TERMINALS. THE AMP IS NOT COMMON GROUND TYPE ARCHITECTURE.

AMPLIFIERS POWER REQUIREMENTS:					
Model 8-50 (120VAC)	Input Power 100-120VAC	Output Power (sinewave) Max Power All Channels 8 ohm or 4 ohm	Input Power	15 AMP Breaker Qty of Amplifiers	20 AMP Breaker Qty of Amplifiers
		1/8 Power All Channels @ Idle @ Standby	<200W 30W <0.5W	600W 9 (120VAC)	3 (120VAC) 4 12 (120VAC)
Model 8-50 (230VAC)	Input Power 220-240VAC	Output Power (sinewave) Max Power All Channels 8 ohm or 4 ohm	Input Power	15 AMP Breaker Qty of Amplifiers	20 AMP Breaker Qty of Amplifiers
		1/8 Power All Channels @ Idle @ Standby	<200W 30W <0.5W	600W 18 (230VAC)	6 (230VAC) 8 24 (230VAC)
Model 16-50 (120VAC)	Input Power 100-120VAC	Output Power (sinewave) Max Power All Channels 8 ohm or 4 ohm	Input Power	15 AMP Breaker Qty of Amplifiers	20 Amp Breaker Qty of Amplifiers
		1/8 Power All Channels @ Idle @ Standby	<200W 50W <0.5W	600W 9 (120VAC)	3 (120VAC) 4 12 (120VAC)
Model 16-50 (230VAC)	Input Power 220-240VAC	Output Power (sinewave) Max Power All Channels 8 ohm or 4 ohm	Input Power	15 AMP Breaker Qty of Amplifiers	20 AMP Breaker Qty of Amplifiers
		1/8 Power All Channels @ Idle @ Standby	<200W 50W <0.5W	600W 18 (230VAC)	6 (230VAC) 8 24 (230VAC)

Figure 7: Power Requirements

NOTE: THE AMPLIFIERS DO NOT SUPPORT MATRIX VOLUME CONTROL. RELATIVE SOURCE LEVELS BETWEEN ZONES AND ZONE/BUS INPUTS MUST BE SET AT THE SIGNAL SOURCE.

IMPORTANT: USE CAUTION WHEN SETTING VOLUME LEVELS EITHER ON THE AMPLIFIER OR AN AUDIO SWITCHER AS NOT TO OVERDRIVE AND POSSIBLY DAMAGE SPEAKERS. VERIFY ALL SOURCES AS OUTPUT VOLTAGE VARIES FROM DEVICE TO DEVICE.

SPEAKER CONNECTIONS

The removable Speaker Block Connectors used on the amplifiers will accept up to 12-gauge wire. Make sure no bare wires are in contact with the amplifier chassis. These have four terminals actuated by small flat head screws which can be used for normal stereo or bridged mode.

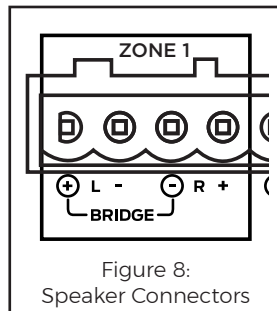

NOTE: ALWAYS CHECK LOCAL BUILDING CODES BEFORE INSTALLING WIRE IN WALLS OR CEILINGS.

BRIDGING CHANNELS

IMPORTANT: THE MINIMUM SPEAKER IMPEDANCE FOR BRIDGED OPERATION IS 8 OHMS. DO NOT CONNECT SPEAKERS RATED AT LESS THAN 8 OHMS IN BRIDGED MODE. THE AMPLIFIER CAN RUN HOT, MAY GO INTO PROTECTION AND HAVE A REDUCED LIFESPAN.

Bridge Mode/Bridging

Bridging an adjacent pair of amplifier channels inverts the phase to the right channel and drives the left and

right channels together in series to generate higher output. Bridging an amplifier can produce up to twice the driving voltage and four times the power. The additional power in bridge mode can be advantageous for driving a passive woofer such as the Visual Performance VP85RW or an 8 Ohm outdoor satellite and subwoofer system such as Patio Series. The downside will be giving up some of the amplifier channels and the speaker impedance must be 8 Ohms or above.

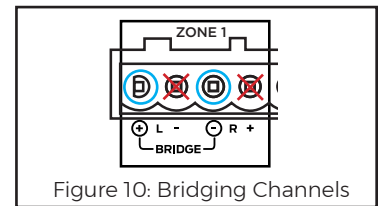
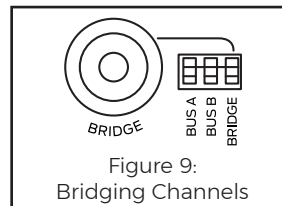

For bridging, use the left Local Input or the left Bus Input when operating the amplifiers output in bridged mode. Use the DIP switch to select the input you would like to assign to the bridged output.

1. Set the zone's Bridge switch to the ON position.
2. Connect the speaker's "+" lead to the left side of the connector marked "+" (first speaker lead from the left).
3. Connect the speaker's "-" lead to the right side of the connector marked "-" (third speaker lead position from the left).

Zone Speaker Outputs

The removable block connectors used on the Sonance 16-50 or 8-50 amplifier will accept up to 12 gauge wire. Follow the connection layout on the rear panel of the amplifier. Make sure no bare wires come in contact with the amplifier chassis. When bridging channels, use the first and third terminations on each connector (marked on the chassis). The positive wire from the speaker should be on the left side connection and the negative connection should be on the right side.

PROTECTION CIRCUITRY AND LEDS

Sonance amplifiers have a multi-stage protection system to prevent damage to your amplifier and speakers.

Amplifier Channel Protection

If a channel encounters a short circuit or extremely low impedance, it will cause the affected channel outputs to automatically mute. The output of the effected channel will remain muted until the fault has been corrected. Only the effected channels output will mute, all other channels will continue to operate normally.

Amplifier Channel Protection Indication

On the front panel of the amplifier are multi color indicators that illuminate to indicate the current operating status of each amplifier zone.

IMPORTANT: DO NOT EXCEED 100MA OF CURRENT DRAW. DAMAGE CAN OCCUR.

Indicator color/status:

Red = Zone protection

Yellow Flashing = Zone overdriven

Blue = Normal status with signal detected

White = Normal status with no signal detected

Off = No power/standby

IMPORTANT: ALLOWING THE AMPLIFIER TO OPERATE WITH ONE OR MORE CHANNELS IN PROTECT MODE FOR AN EXTENDED TIME CAN DAMAGE THE AMPLIFIER.

Amplifier Over Temperature Protection

The amplifier also has protection for the power supply. If the power supply heat sink temperature exceeds the design maximum, the protection circuit will activate, disconnecting all channel outputs. This is indicated by a flashing red power status indicator.

IMPORTANT: ANY TIME THE PROTECTION CIRCUITS ARE TRIGGERED, UNPLUG THE AMPLIFIER'S POWER CORD FROM THE WALL OUTLET BEFORE TROUBLESHOOTING.

PROTECTING SPEAKERS FROM DAMAGE

To protect speakers from being 'blown' by overdriving the amplifier, Sonance recommends setting a safe, maximum volume limit for each channel pair.

This can be accomplished by reducing the output volume controls located on the rear panel of the amplifier. Please note the Sonance speaker warranty does not cover blown, user damaged speakers. The warranty covers

manufacturing defects. Consequently, it is imperative to adjust the output level controls before playing the speakers to protect them following the instructions below.

1. Select two or three challenging music selections that will test the dynamic capabilities of the speakers. Choose dynamic tracks with substantial bass impact from synthesizer, bass guitars and drums. Such tracks will provide 'a worst case scenario' for the speakers. It is best to use uncompressed, high-resolution music, not MP3s.
2. Reduce all zone output volume level controls on the amplifier to minimum. This is a critical step before proceeding any further.
3. Turn the zone preamp or a source with variable output volume up to the maximum level.
4. Play the first music selection.
5. Slowly increase the Output Volume Level of the first amplifier pair, stopping when even the least amount distortion or stress is detected.
6. Decrease the volume below this point.
7. Play your other challenging music tracks and ensure zero distortion on these selections as well. If any hint of distortion is heard, decrease the volume setting just below this point.
8. Once you find this maximum volume, leave the controls at these settings. Advise others who may access the amplifier that increasing the controls beyond these settings can damage the speakers and void their warranty.

There is a limit of how loud an audio system will play before distortion occurs. If this point is noted and not exceeded, most Sonance speakers and amplifiers will operate safely for years.

AMPLIFIER STACKING

The amplifier is capable of being directly stacked with the feet removed for use in low to moderate output applications. For high-output applications, it is recommended to leave at least 1U space between amplifiers for increased ventilation.

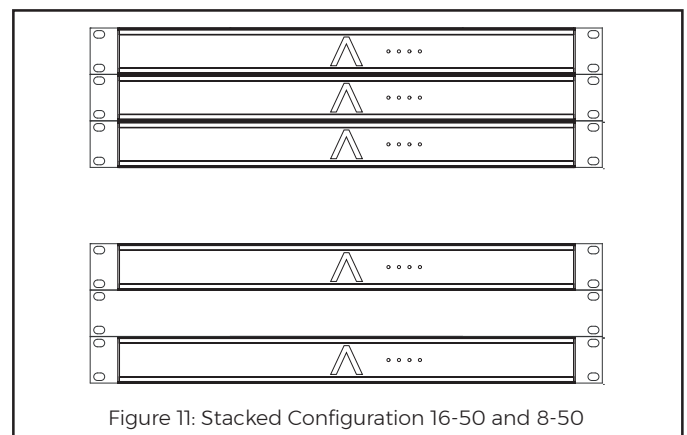

Figure 11: Stacked Configuration 16-50 and 8-50

SHELF MOUNTING

If shelf mounting, attach the four included feet by screwing them into the threaded openings, no tool is required.

EQUIPMENT RACK MOUNTING

The amplifier ships with two short rack ears (left and right) that attach to its sides. Unscrew the two Phillips head screws found on each side of the left and right forward section of amplifier. Use these screws to connect the included rack ears to the amplifier. The rack ears are unnecessary for shelf mounting.

Rack Ear Configuration Options

The amplifier chassis has threaded inserts on the sides to accept mounting of the ears in the designated locations:

Front: Standard rack mounting

Middle Up: Under side mounting applications

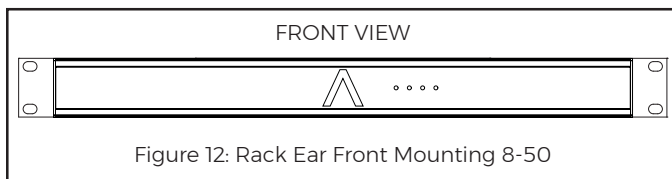

Figure 12: Rack Ear Front Mounting 8-50

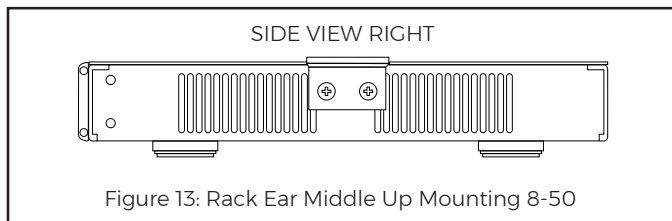

Figure 13: Rack Ear Middle Up Mounting 8-50

SYSTEM EXAMPLES

Installation Steps With A Single Audio Source

1. Once mounted in a rack or on a sturdy shelf, make sure it is in the OFF state. The rear panel power switch should be in the down position.
2. Decide on the appropriate Power Sensing Mode: voltage, audio signals or the 'always on' Off position (such as for the passing paging or doorbell chimes).
3. Set the Sense DIP switch accordingly.
4. If using the voltage trigger feature, connect a two-conductor wire from the 12 volt output of a zone preamp or DC power supply into the 'V Trigger' inputs.
5. Connect a pair of RCA cables from the single source into the Left and Right Audio Inputs for Bus A.
6. Set the Input Assignment DIP switches to the Bus A inputs, alternating between left channel and right channels.
7. If using the Bus Inputs along with a passive woofer/subwoofer (ex: VP85RW) in a zone, connect a single RCA cable from the SUB OUT on the amplifier to the amplifier driving the woofer. The audio output of the SUB OUT is low pass filtered, so the amplifier driving

the woofer does not have to perform this function. See section 'Using The Subwoofer Line-Level Output Feature'.

8. Connect 14/4 speaker wire from the remote zones to their dedicated Speaker Output Block Connector on the amplifier.
9. If the AC cord is disconnected, then reconnect it.
10. Push the power rocker switch up to the ON position.
11. With the source volume turned down to a low, speaker friendly level, turn on the amplifier and play music. If you do not hear any sound, refer to the 'No Audio' section of the troubleshooting chapter.
12. Follow the steps in the chapter entitled, 'Protecting Speaker from Becoming Damaged'.

INSTALLATION STEPS WITH FOUR SOURCES

1. After mounted in a rack or on a sturdy shelf, make sure it is in the OFF state. The rear panel power switch should be in the down position.
2. Decide on the appropriate Power Sensing Mode: voltage, audio signals or the always on 'OFF' position.
3. Set the Sense DIP switch accordingly.
4. If using the voltage trigger feature, connect a two-conductor wire from the 12 volt output of a zone preamp or DC power supply into the 'V Trigger' inputs.
5. Connect a pair of RCA cables from each stereo source into their dedicated local source inputs.
6. Set the Input Assignment DIP switches to local. If paging or door chimes are not used, proceed to step 8.
7. If providing doorbell chimes and/or paging into the amplifier, run a line level cable from the door chime generator's audio output into the Bus A input. If also providing paging, run a line level cable from the paging system's line-level output into the Bus B Input. Set all the Input Assignment DIP switches to ON. These connections and DIP switch setting will pass audio, door chimes and paging at all times.
8. If using the Bus Input source along with a passive woofer/subwoofer (ex: VP85RW) in a zone, connect a single RCA cable from the SUB OUT on the amplifier to the amplifier driving the woofer. The audio output of the SUB OUT is low pass filtered, so the amplifier driving the woofer does not have to perform this work. See section below, 'Using The Subwoofer Line-Level Output Feature'.
9. Connect 14/4 speaker wire from the remote zones to their dedicated Speaker Output Block Connectors. For example, if the audio source for the kitchen is connected into channels one Left and one Right RCA

inputs, then connect the 14/4 speaker wire from the kitchen speakers into the Speaker Block Connector plugged into the first amp pair.

10. If the AC cord is disconnected, then reconnect it.
11. Push the power rocker switch up to the ON position.
12. With the source volume turned down to a low, speaker friendly level, turn on the amplifier and play music. If you do not hear any sound, refer to the 'No Audio' section of the troubleshooting chapter.
13. Follow the steps in the chapter entitled, 'Protecting Speakers from Becoming Damaged'.

TROUBLESHOOTING

Recommended Troubleshooting Tools

- A small flat blade jewelers screwdriver for the screws in the Speaker Block Connector.
- A pair of verified working RCA interconnect cables.
- A single or a pair of verified working test speakers, such as Sonance Mariners.
- A short run of 14/2 or 14/4 speaker wire to connect the local test speaker, 6-10' (1.8-3m) in length.
- AC 'Cheater' plug to temporarily lift an AC ground.
- Optional multimeter to read short circuits, open circuits and to take speaker resistance and continuity measurements.

MULTIMETER TEST FOR OPEN AND SHORTED WIRE AND SPEAKERS

The measurement will be across the two-conductor speaker wires leading to a speaker in the remote zone. The two wires and the speaker comprise a circuit. Connection of a multimeter will complete the circuit. If working with a four-conductor wire, then test one set of wires and its speaker at a time.

PLEASE NOTE: A SPEAKER WITH A SWITCHABLE HIGH-PASS FILTER IN THE CROSSOVER, SUCH AS AN AS38R/S OR VP38R/S, WILL NEED TO HAVE THE SWITCH IN THE OFF POSITION TO TAKE A DCR READING. OTHERWISE, THE CAPACITOR IN THE HIGH PASS FILTER WILL BLOCK THE DC SENT FROM THE METER AND THE LOAD WILL SHOW 'OPEN'. REMEMBER TO SET THE HIGH PASS FILTER SWITCH BACK TO ON AFTER TAKING THE DCR READING.

1. Turn off the amplifier before connecting or disconnecting any cabling.
2. Disconnect the speaker wires from the Speaker Block Connector.
3. Set multimeter to measure DC, apply the meter probes across the two-conductor speaker wire for one of the channels not producing sound. Use the red meter probe for the "+" wire and the black probe for the "-" wire. This will test the wiring and the connected speaker for any issue.

4. If the meter reads 'INFINITE' or very high resistance, then the circuit is open. No continuity exists between the speaker wires and the speaker. Either the wire is open (cut) somewhere between the amp and the speaker, the speaker is not physically connected to both wires or the speaker has become severely compromised (open/blown voice coil from excessive bass).
5. If the DC measurement is zero or close to zero, then the circuit (wire and speaker) has become shorted somewhere. This could be from a staple shorting across the speaker wires or the speakers have been severely damaged by excessive power or over-excursion from too much bass resulting in a short.
6. If the DC measurement is between 6-8 Ohms (for a single 8 Ohm speaker), then the circuit has continuity and the problem is internal.
7. A speaker from the zone can also be tested directly as above for continuity. If the speaker is installed in a ceiling or wall, then remove it. Apply the meter probes directly across the "+" and "-" input terminals of the speaker. Most 8 Ohm speakers will measure between 5-7 Ohms of DC resistance. If the measurement is close to zero (shorted) or infinite (open), then the speaker will need to be replaced.

TROUBLESHOOTING: NO POWER

Potential Reasons

- The AC cord for the amplifier is not fully inserted into the IEC power connector on the amp's back panel.
- The AC outlet is connected to is not active or its GFCI circuit has been tripped (Ground Fault Circuit Interrupt).
- The power switch on the rear panel is set to the 'down' off position.

The 16-50 and 8-50 are shipped with the Power Sense switch set to OFF. When the amplifier is plugged into a live AC outlet and the rear panel power switch is depressed, the front panel power status 'A' indicator should illuminate.

Steps to Resolve

If the front panel 'A' power status indicator does not illuminate:

1. Double-check that the amp's AC power rocker switch is in the up on position.
2. Ensure the detachable AC cord connector is fully inserted into the back panel IEC power receptacle.
3. Check if the AC cord's male plug is plugged into a live working AC outlet. If necessary, plug another appliance such as a lamp into the same AC outlet as the amplifier. If the lamp does not light, then the AC outlet's circuit breaker or GFCI circuit may need to be reset or the outlet otherwise evaluated for proper functionality.
4. Remove the amp and take it to another location in the residence. Plug it into a different, known working

AC outlet.

5. Try a second IEC AC power cord. Although they rarely fail, a failure is still remotely possible.
6. If the amplifier's display 'A' letter still does not illuminate with all these steps, then please contact the Sonance dealer the amplifier was purchased from or Sonance Technical Support: technicalsupport@sonance.com

TROUBLESHOOTING: NO AUDIO

Applicable to one or both paired channels, such as the 16-50's or 8-50's 1L and 1R inputs below. For troubleshooting, a 'source' is defined as the audio component providing line-level audio into the 8-50, such as the second zone outputs on an AV receiver, a pair of zone outputs of a multi-zone controller, music server, tuner, iPhone, etc.

Potential Reasons:

- A fault in the interconnect cable between the source and the amplifier.
- RCA cables are plugged into the input on the source instead of the output.
- A fault in the source providing audio input.
- A fault in the speaker wire and/or its connections, either at the Speaker Block Connector at the back of the amplifier or at the speaker location in the zone.
- A fault in the speaker in the remote zone.
- The DIP switches for the audio input selection are set incorrectly.
- Volume controls are all the way OFF.
- An internal fault has occurred in the amplifier.

If one of the internal amplifiers does not provide audio output to the speakers and the protection LEDs on the front panel are not illuminated, proceed to step 1 below. If the protection LEDs are illuminated, proceed to step 6 below.

IMPORTANT: BEFORE DISCONNECTING OR RECONNECTING AUDIO CABLES OR SPEAKER CONNECTIONS, TURN THE AMPLIFIER OFF. ONCE THE CONNECTIONS ARE REMADE, THEN TURN THE AMP BACK ON. MAKING OR BREAKING LINE-LEVEL RCA CONNECTIONS WITH THE AMPLIFIER POWERED ON CAN DAMAGE THE AMPLIFIER AND/OR THE SPEAKERS.

Steps to Resolve

1. Check the line-level RCA interconnect cable and its connections from the source into the amplifier. Make sure the RCA plugs are pushed all the way into the jacks. Hum can result if the RCA male plug is only partially inserted in the RCA jacks. If the cable is 'open' (bad RCA connector or cable), then replacing the cable should restore functionality. Use a new cable or temporarily use one of the RCA cables from another zone on the amplifier. If there is still no sound, proceed to step 2.
2. Try the output of another source into the non-

functioning amplifier. For example, if using the outputs of a second zone of an AV receiver, try the zone 3 output or the variable output of a music server, portable music player or satellite tuner.

3. Examine the speaker wires inserted into the Speaker Block Connector. Are all the wires securely inserted into the connector without breaks, the wires being loose or strands touching? Re-secure any suspect wires, plug the connector back into the amp, turn the amp back on and check for output. If still no output, proceed to the next step.
4. Unplug the Speaker Block Connector. Disconnect the current speaker wires from the block connector. Using a short run of speaker wire, connect a local test speaker into the block connector. Plug the block connect back into the amp, turn the amp back on and test for audio output. If the test speaker is now producing audio, then there could be an 'open circuit' at the remote zone speakers, meaning one of the connections has been compromised. An alternative is to disconnect the Speaker Block Connector from a known working zone and plug it into the non-working zone. Does the amplifier now produce sound? If yes, then the wiring between the amp and the speakers may have been compromised. If no, then the non-functioning amplifier may have an internal fault that for whatever reason is not lighting the protection LEDs. Please contact Sonance Technical Support to initiate an RMA.
5. Check the position of the source select switch.
6. If the front panel zone LEDs are illuminated red, disconnect the Speaker Output Block Connector. If the protection LEDs remain on with the Block connector unplugged, then the amplifier may have an internal fault. There is no reset procedure. The amplifier will need to be returned to Sonance on an RMA (see warranty section). If the LEDs go out when the block connector is unplugged, then try step 4 above. Is the amplifier now functioning properly? If yes, then there could be a short in the speaker wires leading to the remote zone or the speakers have become shorted/damaged from excessive power.

TROUBLESHOOTING: NO BASS AND 'HOLLOW-SOUNDING' VOICES FROM A PAIR OF SPEAKERS OR A SINGLE STEREO SPEAKER

Potential Reasons

- The most common reason is one speaker pair is wired in reverse polarity. There are four speaker wire connections on each pair of channels. Left channel positive, left channel negative, right channel positive and right channel negative. Using color coded four conductor wire simplifies the connections at both the amplifier and speakers. Typically, right channel positive uses the red conductor, right channel negative uses the black conductor, left channel positive uses the white conductor and left channel negative uses the green (or blue) conductor. If one

of these four connections are reversed at either the amplifier or at the speakers, then one speaker will be moving outward while the other speaker will be moving inward. This will cause bass cancellation and voices to sound 'hollow' or emanating from the sides of the speakers instead of between them.

- The speakers are supplied with a high-passed signal rather than a full-range signal. A high-passed signal will have significantly reduced bass output below a given frequency.
- One or both of the woofers in the speakers have an issue.

Steps to Resolve

1. Turn off the amplifier before connecting or disconnecting any cabling.
2. Check the speaker wire polarity at the amplifier and at the speakers. For example, if the red and black wires are reversed at the amplifier, with the black wire connected to the right channel positive and the red wire connected to the right channel negative, reverse them.
3. Turn the power on the amplifier back on and play the speakers. Do the speakers have better bass and do voices seem to emanate somewhere between the speakers? If yes, then you have solved the polarity problem.
4. If the wiring looks correct at the amplifier, then the polarity reversal may be at the speaker location. If the speakers are inaccessible and reversing their wire polarity is impractical, then reversing the polarity at the amplifier may be the best option.
5. If the wire/speaker polarity is not the issue, ensure the line-level input signals are full-range and not being filtered at the source. If necessary, connect a local full-range source to the left and right inputs on the suspect amplifier pair, such as the audio output of a mobile audio device.
6. With a second, known working source in place, do the speakers now have full-range sound? If yes, then the preamp supplying the audio signal to the suspect channels in the amplifier should be investigated.
7. If the speakers still do not have much bass output, connect a different, properly working pair of test speakers to this amplifier pair in question. Do the local test speakers have good bass? If so, then the speakers in that zone will need to be uninstalled and tested separately; replace one or both speakers as necessary.

LOW AUDIO VOLUME

Potential Reasons

- The source providing the audio signal into the amplifier has inadequate output voltage.
- The volume control on the source is turned down.

- The volume controls on the back panel of the amplifier are turned down.

Steps to Resolve

1. Determine the voltage output rating of the source feeding the amplifier. Some source components such as music-servers, CD players and tuners have sufficient output voltage for use with a preamplifier, but insufficient for use with a power amplifier. If the source is rated for the same output voltage as the input sensitivity rating of the amplifier (or greater), then this is not the cause of the low volume. If the output voltage of the source is below the input sensitivity rating, then a preamp will need to be inserted between the two.
2. Check the volume control setting on the source (if applicable). Some sources such as a DVD player have fixed line-level outputs that cannot be varied. Increase the volume output on the source if its variable.
3. Check the setting of the volume controls on the back panel of the amplifier. Turn them up as necessary, but below the point they cause distortion in the speakers. The primary reason the amplifier has volume controls is to protect the speakers from being overdriven and damaged.

TROUBLESHOOTING: DISTORTION

Potential Reasons

- The source providing audio input to the amplifier has distortion and the amplifier is reproducing it.
- The source is providing too high of an output signal and it's overdriving the input stage on the amp.
- The RCA cable connecting the source to the amplifier is compromised.
- The speaker wire has been shorted somewhere between the speaker and the amplifier.
- The speakers have been overdriven and damaged.
- The 16-50 or 8-50 has an internal fault.

Steps to Resolve

1. Turn off the amplifier before connecting or disconnecting any cabling.
2. Check the Speaker Block Connectors to ensure wire strands from adjacent connections are not touching and shorting out. Ensure all the wires are correctly and securely inserted into the Speaker Block Connector and are not loose. A complete short will normally trigger the protection circuitry and mute the shorted channels. However, the amplifier can drive a 'partial' short or an excessively low impedance to a certain level, but with attendant distortion. Make sure the speaker impedance is 4 Ohms and above for each channel.
3. Substitute another, known working RCA cable between the source and the inputs.

4. Substitute a different, known working source component into the amplifier, especially one with variable volume. If the second source does not have variable volume, then reduce the amp's volume controls to prevent overdriving the speakers before playing the alternate source.
5. Test the speakers with a different, distortion free amplifier or pair of channels on the amplifier. If the distortion remains, then the speakers are likely damaged and need to be replaced. Before playing the replacement speakers, please review the chapter entitled, 'Protecting Speakers From Becoming Damaged'.
6. Disconnect the Speaker Block Connector, loosen the screws, remove the speaker wires and substitute a test speaker and two conductor wire. Plug the speaker block connected back into the amplifier and turn the power back on. If the test speaker does not have distortion, then the problem is in the wiring leading to the zone or in the zone speakers.
7. If the connections on the Speaker Block Connector are correct, both channels of the RCA cable are working and distortion free, the source into the amp is not distorted but the local test speaker is distorted, then an internal fault has occurred in the amplifier.

TROUBLESHOOTING: HUM

Hum is defined as a constant 50Hz or 60Hz tone and its related low harmonics (buzz).

Potential Reasons

- The introduction of a satellite receiver or cable box into the audio system can cause a ground loop, resulting in audible hum.
- The speaker or the speaker wires are in very close proximity to the transformer in the low voltage lighting system (< 6"/152.4mm).
- The amplifier has a different AC ground potential than the other audio/video components.

Steps to Resolve

1. Turn off the amplifier before connecting or disconnecting any cabling.
2. Temporarily reduce the audio system to a bare minimum for troubleshooting. If the amplifier is connected to an audio system with an AV receiver, cable box and/or satellite receiver, then turn off the receiver. Disconnect the line-level inputs.
3. With all the line-level inputs disconnected, is the hum still audible through the speakers? If yes and the amplifier is mounted in a metal rack, uninstall the amplifier from the rack and place it on the floor. With its inputs disconnected and the amplifier not physically grounded to the rack, then the hum should disappear. If it does not, then there may be an internal fault in the amp.
4. Connect a mobile audio device using its headphone

output with a 'stereo mini to two RCA male adaptor cable' into the amplifier channels with the hum. A phone with stored music is an ideal source since it's not connected to the local AC ground. A CD, music streamer, or another audio source with a two prong AC plug can also be used if an iPhone is unavailable.

5. Turn the amplifier back on, play music at typical volume level and then pause the music. If the hum is gone, then the problem is likely caused by a system ground loop. One method of eliminating the hum is with a ground loop isolator with RCA inputs and RCA outputs.
6. If the hum is still present, consider temporarily using an AC 'cheater' plug, also called a three to two AC adaptor. This will lift the AC ground from the amplifier. Do not leave this adaptor in place permanently as a safety precaution. If lifting the AC ground solves the problem, consider using an AC hum eliminator/lifter on the component introducing the hum to the system.
7. If any of the in-ceiling speakers are close to the low voltage lighting transformers, then the speakers will need to be moved, the transformers moved away from the speakers or at least the crossovers on the speakers will need to be moved. The inductors in the speaker's crossover network can pick up low voltage lighting transformer hum if they are close together.

TROUBLESHOOTING: NOISE

Noise is defined as any undesirable sound added to the input signal. Except hum or its related harmonics. Please see the above troubleshooting section regarding hum.

Potential Reasons

- The source providing audio input to the amplifier has noise and the amplifier is reproducing it.
- Poorly shielded or defective line-level RCA cables between the audio source and the amplifier.
- Damaged speaker voice coils and/or suspension components (torn spider and/or woofer surround) can result in a 'popping' or 'cracking' sound.
- Drywall debris, insulation or other extraneous material has fallen into the speaker and resting against the backside of the woofer cone.
- An improperly terminated two wire speaker connection in which strands from one wire are in contact with the second wire.
- The amplifier has an internal fault.

Steps to Resolve

1. Turn off the amplifier before connecting or disconnecting any cabling.
2. Connect a different, low noise audio source into the amplifier channels with the noise. If the noise disappears, then the source has the noise and not the amplifier.

3. If the noise remains, ensure the RCA cables are good quality, do not have crimps or kinks and are properly shielded.
4. Connect a pair of speakers from a different zone that does not have the noise. Pull out the Speaker Block Connector from the suspect channels on the amplifier, do the same with another zone and plug the known working speakers into this zone. If the noise disappears, then the suspect zone speakers may be damaged and need replacement.
5. Replace the damaged speaker(s) and set the volume controls on the back panel below the point at which the amplifier distorts and/or the speakers become overdriven. Please review the chapter entitled, 'Protecting Speakers From Becoming Blown/ Distorted'.
6. If the noise is heard only from one zone or one channel of a zone, connect a known working, problem free source to this zone. Turn the amplifier back on and listen for the noise. If the noise disappears, then the problem is with the source. If the noise remains, connect a test speaker to the channel(s). Does the noise disappear with the test speaker? If yes, then the problem may be in the zone's speaker or wire connections. If the noise remains and all the previous troubleshooting steps have been performed, then the problem lies within the amplifier.

TROUBLESHOOTING: FRONT PANEL PROTECTION LEDS ARE ILLUMINATED

Potential Reasons

- The amplifier is in a poorly ventilated area and has over heated. Although fan cooled, it still requires good ventilation.
- The speaker wires are shorted either at the Speaker Block Connector on the rear panel, somewhere between the amplifier and the speaker location, or at the speaker location.
- The speakers have been damaged such that they appear as a short to the amplifier.
- Too many speakers are connected to an amplifier pair on the amplifier. It is compatible with 4 ohm loads and above, which is one pair of 4 ohm speakers, one pair of 6 ohm speakers or two pairs of 8 ohm speakers.

Steps to Resolve

1. Ensure the amplifier is on a shelf or at the lowest place in a rack that has good circulation of fresh air to dissipate heat. Do not locate the amplifier in a closed cabinet or closet with little ventilation as this can trigger its thermal protection circuit and reduce its service life.
2. Disconnect the Speaker Block Connector from the pair of amp channels in protection. If the protection LEDs go out, the short is external to the amplifier. If the protection LEDs remain on, then this can

be caused by DC appearing on the RCA inputs or an internal problem in the amplifier. Substitute a different source from a pair of channels that are not in protection. If the protection LEDs go out and the substitute speakers have sound, this indicates a problem with the source such as DC and not the amplifier.

3. Check the speaker wire for shorts, adjacent channel wires touching each other, construction staples accidentally driven through the speaker wire in a wall or attic, etc. Examine the wire connection in the Speaker Block Connector. Substitute a different Speaker Block Connector. With connected speakers from a working zone. If the protection LEDs go out and the speakers have sound, then there is a short with the wire and/or speakers that were originally connected.
4. If two pairs of speakers are connected to a pair of amplifier channels, ensure both pairs are rated at 8 Ohm. If the speakers are rated for a lower impedance, then this may be triggering the amplifier's protection. Either use an impedance matching device between the amp channels and the speakers, connect the additional speakers to additional amp channels on the amplifier if they are available, or purchase an additional amplifier for this purpose.

UNINSTALLING THE AMPLIFIER FOR RELOCATION OR SERVICE

1. Turn the amplifier off with the power switch on the back.
2. Pull out the removeable AC Power Plug from the AC socket on the back.
3. Disconnect all the RCA line-level cable inputs on the back.
4. If the removal is temporary, unplug the Speaker Block Connector, leaving the wiring in place. If the removal is permanent, use a small flat head screwdriver to loosen the speaker wire securing screws on the Speaker Block Connector and remove the speaker wires.
5. If the relocation is permanent, then re-insert the Speaker Block Connector into the speaker outputs on the back of the amplifier.
6. If the unit is rack mounted, remove the rack mount screws from the front of the amplifier, taking care to properly support its weight until all the rack screws have been removed.
7. Store the rack mount screws and other miscellaneous hardware in a resealable plastic bag. Label the bag as, 'Sonance 16-50 or 8-50 rack mounting hardware' so its easily identifiable in the future and store it in a known place.
8. Remove the amplifier from the rack and repack it in its original factory carton to keep it safe and undamaged.

SONANCE 16-50 TECHNICAL SPECIFICATIONS

Number of Channels	16 (8 stereo zones)
Power Output - 8 Ohms	50 watts RMS per channel (all channels driven)
Power Output - 4 Ohms	100 watts RMS per channel (all channels driven)
Power Output - 8 Ohms (Bridged)	200 watts
Frequency Response	10Hz – 22kHz (+/-1dB)
Signal to Noise Ratio	>100 dB A-wtd
Crosstalk	Better than -80 dB, typical, 1kHz
Voltage Trigger Input	3-30Vdc
Audio Sense Threshold	1.5 mVrms
Crossover Filter	OFF/80Hz/120Hz
AC Mains Voltage	100-240V~/50-60Hz
Rack Space Requirement	1U - Full Width
Dimensions w/Feet (WxHxD)	17.2" x 2.2" x 12.3" (436mm x 55mm x 312.5mm)
Dimensions w/Rack Ears no Feet (WxHxD)	19" x 1.75" x 12.3" (482mm x 44mm x 312.5mm)
Shipping Weight	13.4 lbs (6.1kg)

SONANCE 8-50 TECHNICAL SPECIFICATIONS

Number of Channels	8 (4 stereo zones)
Power Output - 8 Ohms	50 watts RMS per channel (all channels driven)
Power Output - 4 Ohms	100 watts RMS per channel (all channels driven)
Power Output - 8 Ohms (Bridged)	200 watts
Frequency Response	10Hz – 22kHz, bandwidth limited
Signal to Noise Ratio	>100 dB A-wtd
Crosstalk	Better than -80 dB, typical, 1kHz
Voltage Trigger Input	3-30Vdc
Audio Sense Threshold	1.5 mVrms
Crossover Filter	OFF/80Hz/120Hz
AC Mains Voltage	100-240V~/50-60Hz
Rack Space Requirement	1U - Full Width
Dimensions w/Feet (WxHxD)	17.2" x 2.2" x 12.3" (436mm x 55mm x 312.5mm)
Dimensions w/Rack Ears no Feet (WxHxD)	19" x 1.75" x 12.3" (482mm x 44mm x 312.5mm)
Shipping Weight	12.7 lbs (5.8kg)

REPLACEMENT ACCESSORY PARTS

16-50 (North America Model):	93546
16-50 (International Model):	93547
8-50 (North America Model):	93544
8-50 (International Model):	93545
Amp Feet:	93558
Rack Ears:	93559
Speaker Block Connector:	144173
Voltage Trigger Block Connector:	144174
AC Cord:	600393

International SKUs do not include an AC Cord.
Contact Sonance Customer Service to order parts:
customerservice@sonance.com

LIMITED TWO (2) YEAR WARRANTY

Sonance warrants to the first end-user purchaser that this Sonance-brand product (Sonance 16-50 or 8-50) when purchased from an authorized Sonance Dealer/Distributor, will be free from defective workmanship and materials for the period stated below. Sonance will at its option and expense during the warranty period, either repair the defect or replace the Product with a new or remanufactured Product or a reasonable equivalent.

EXCLUSIONS: TO THE EXTENT PERMITTED BY LAW, THE WARRANTY SET FORTH ABOVE IS IN LIEU OF, AND EXCLUSIVE OF, ALL OTHER WARRANTIES, EXPRESS OR IMPLIED, AND IS THE SOLE AND EXCLUSIVE WARRANTY PROVIDED BY SONANCE. ALL OTHER EXPRESS AND IMPLIED WARRANTIES, INCLUDING THE IMPLIED WARRANTIES OF MERCHANTABILITY, IMPLIED WARRANTY OF FITNESS FOR USE, AND IMPLIED WARRANTY OF FITNESS FOR A PARTICULAR PURPOSE ARE SPECIFICALLY EXCLUDED.

No one is authorized to make or modify any warranties on behalf of Sonance. The warranty stated above is the sole and exclusive remedy and Sonance's performance shall constitute full and final satisfaction of all obligations, liabilities and claims with respect to the Product.

IN ANY EVENT, SONANCE SHALL NOT BE LIABLE FOR CONSEQUENTIAL, INCIDENTAL, ECONOMIC, PROPERTY, BODILY INJURY, OR PERSONAL INJURY DAMAGES ARISING FROM THE PRODUCT, ANY BREACH OF THIS WARRANTY OR OTHERWISE.

This warranty statement gives you specific legal rights, and you may have other rights which vary from state to state. Some states do not allow the exclusion of implied warranties or limitations of remedies, so the above exclusions and limitations may not apply. If your state does not allow disclaimer of implied warranties, the duration of such implied warranties is limited to period of Sonance's express warranty. Your Product Model and Description: Sonance 16-50 or 8-50 Multi-Channel Power Amplifier. Warranty Period for this Product: Two (2) years from the date on the original sales receipt or invoice or other satisfactory proof of purchase.

Additional Limitations and Exclusions from Warranty Coverage: The warranty described above is non-transferable, applies only to the initial installation of the Product, does not include installation of any repaired or replaced Product, does not include damage to allied or associated equipment which may result for any reason from use with this Product, and does not include labor or parts caused by accident, disaster, negligence, improper installation, misuse (e.g. overdriving the amplifier or speaker, excessive heat, cold or humidity), or from service or repair which has not been authorized by Sonance.

Obtaining Authorized Service: To qualify for the warranty, you must contact your authorized Sonance Dealer/Installer or call Sonance Customer Service at (949) 492-7777 within the warranty period, must obtain a return merchandise number (RMA), and must deliver the Product to Sonance shipping prepaid during the warranty period, together with the original sales receipt, or invoice or other satisfactory proof of purchase.

Warranty Process: Please follow the troubleshooting instructions in this manual or work with your Sonance dealer to determine the exact nature of the fault. Sonance provides a 2-Year Limited Warranty to the original owner with proof of purchase from an authorized Sonance dealer. The warranty does not cover shipping charges back to Sonance or the use of the product in an environment or application not approved by Sonance.

In order to initiate a warranty claim:

1. Contact Sonance Technical Support with a description of the fault, the amplifier's serial number and the date of purchase from an authorized Sonance dealer at: technicalsupport@sonance.com
2. Sonance Technical Support will follow-up and may request additional troubleshooting.
3. Once a determination has been made on the fault, Sonance Customer Service will follow-up by email. Please have a scanned copy of your 8-50 or 16-50 sales invoice ready to send upon request to document the amplifier's warranty status.
4. Sonance Customer Service will provide an RMA number to be included on the shipping label of the packaging. Please send the amplifier back in its original factory carton, which has been specifically designed to protect the amplifier during transit.

Contact us at: <https://www.sonance.com/company/contact>

SONANCE

©2022 Sonance. All rights reserved. Sonance is a registered trademarks of Dana Innovations. Due to continuous product improvement, all features and specifications are subject to change without notice. For the latest Sonance product specification information visit our website: www.sonance.com

SONANCE · 991 Calle Amanecer · San Clemente, CA 92673 USA
PHONE: (949) 492-7777 · FAX: (949) 361-5151 · Technical Support: (949) 492-7777
12.13.2022