

REVISIONS				
ECD	REV.	DESCRIPTION	DATE	APPROVED
	A	RELEASE FOR PRODUCTION	02-11-14	
	B	MOD FOR REMOVABLE DRIVERS	06-23-14	
	C	CHANGED BRACKET HOLE LOCATIONS	04-03-15	D. MEI

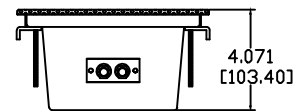
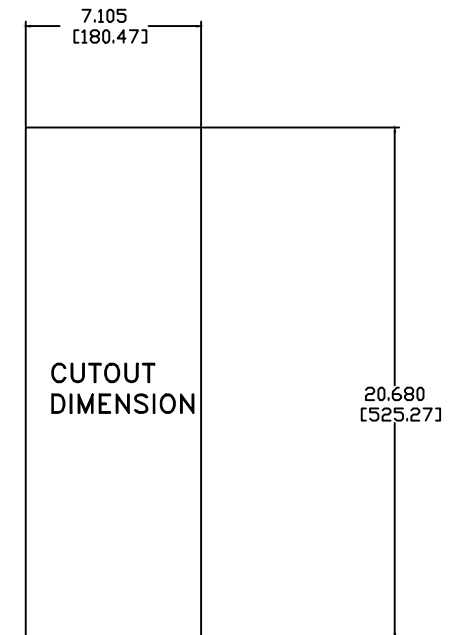
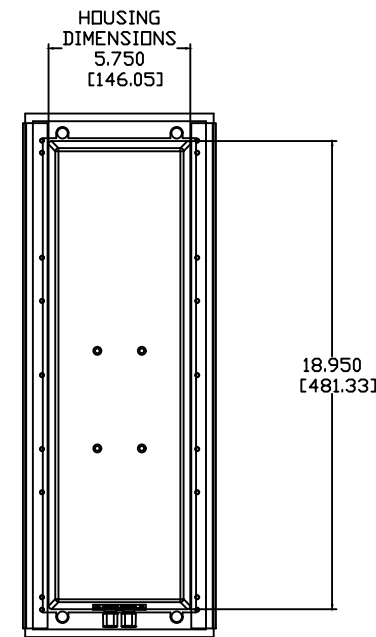
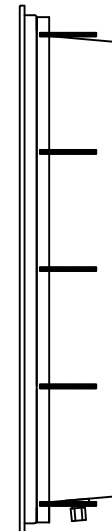
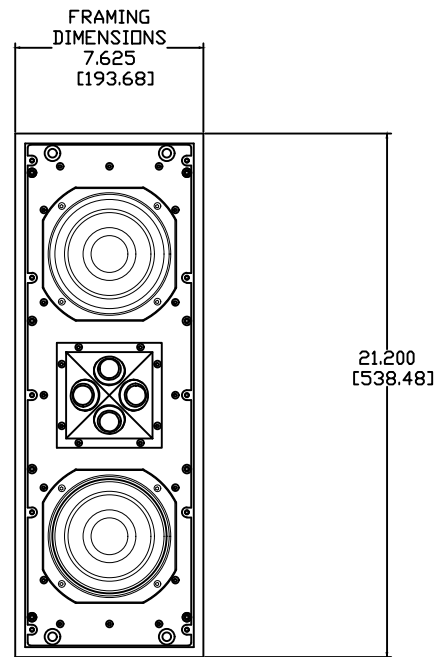
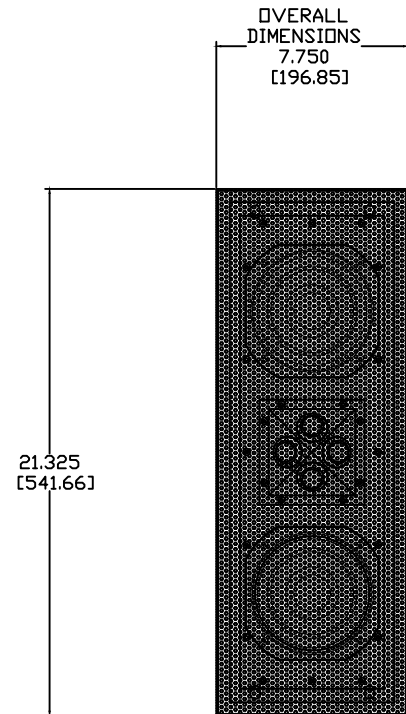
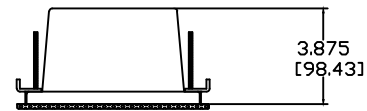

**NOTES:**

- 1: 0.125" THICK 5052 ALUMINUM  
OTHERWISE SPECIFIED
- 2: FRONT PLATE-STUDIO BLACK FINISH
- 3: HOUSING-CLEAR COAT FINISH

**JAMES LOUDSPEAKER**

**QX530**

ASSEMBLY

P/N: -

DWR #: 121112-B01

REVISED BY:

DRAWN BY: M. PARK

FILE:

DATE: 06-23-14

SCALE:

APPROVED:

DRAFTING APPROVED:

DO NOT SCALE DRAWING

DRAWING NOT TO BE USED FOR CNC

TOLERANCES: ANG: ± = .5° FRACT: ± = 1/32

DECIMALS: .XX ± = .01 .XXX ± = .005

REVISION: C

SHEET 1 OF 10